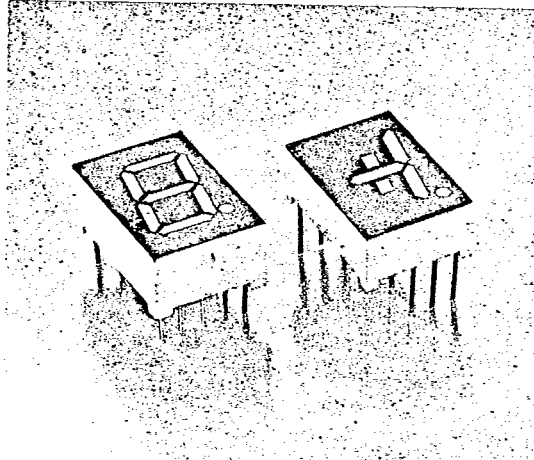

LITEON**LTS-540A SERIES****0.52" SINGLE DIGIT NUMERIC DISPLAYS**

T-41-33

FEATURES

- 0.52 INCH (13.2mm) DIGIT HEIGHT.
- CONTINUOUS UNIFORM SEGMENTS.
- CHOICE OF SIX BRIGHT COLORS-RED/BRIGHT RED/GREEN/YELLOW/ORANGE/HIGH EFFICIENCY RED.
- LOW POWER REQUIREMENT.
- EXCELLENT CHARACTERS APPEARANCE.
- HIGH BRIGHTNESS.
- WIDE VIEWING ANGLE.
- SOLID STATE RELIABILITY.
- CATEGORIZED FOR LUMINOUS INTENSITY.
- I.C. COMPATIBLE.
- EASY MOUNTING ON P.C. BOARD OR SOCKETS.

SEVEN SEGMENT LED DISPLAYS
& ALPHANUMERIC DISPLAYS**DESCRIPTION**

The LTS-540A series are 0.52 inch (13.2mm) height single digit displays.

The red series devices utilize LED chips which are made from GaAsP on a GaAs substrate. The bright red and green series devices utilize LED chips which are made from GaP on a transparent GaP substrate. The yellow, orange and high efficiency red series devices are utilize LED chips which are made from GaAsP on a transparent GaP substrate. Red, bright red, yellow and orange displays have gray face and white segment color. Green displays have gray face and green segment color. High efficiency red displays have red face and red segment color.

DEVICES

PART NO. LTS-						DESCRIPTION	PACKAGE DIMENSION	INTERNAL CIRCUIT DIAGRAM
RED	BRIGHT RED	GREEN	YELLOW	ORANGE	HI.-EFF RED			
546AR	546AP	546AG	546AY	546AE	546AHR	Common Anode, Rt. Hand Decimal	A	A
547AR	547AP	547AG	547AY	547AE	547AHR	Common Cathode, Rt. Hand Decimal	A	B
548AR	548AP	548AG	548AY	548AE	548AHR	Common Anode, ±1 Overflow	B	C
549AR	549AP	549AG	549AY	549AE	549AHR	Common Cathode, ±1 Overflow	B	D

5-60

723

PACKAGE DIMENSIONS

A. LTS-546A/547A

B. LTS-548A/549A

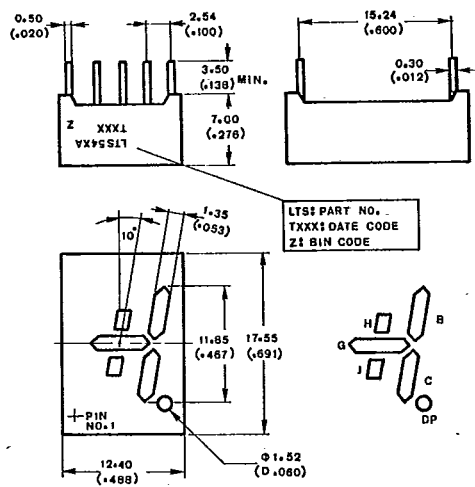
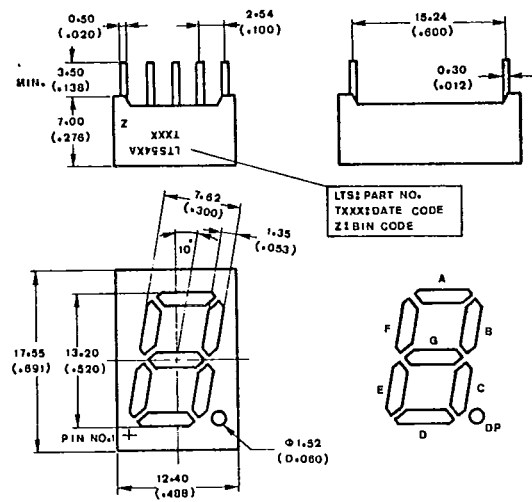

NOTE: All dimensions are in millimeters tolerance are: (inches)

- Lead length (from seating plane): minimum value $\frac{+1.00}{-0.000}$ mm ($\frac{+0.040}{-0.000}$ inches)
- ± 0.25 mm (0.010 inches) unless otherwise noted.

PIN CONNECTION

PIN NO.	CONNECTION			
	A. LTS-546A	B. LTS-547A	C. LTS-548A	D. LTS-549A
1	Cathode E	Anode E	Cathode J	Anode J
2	Cathode D	Anode D	No Connection	No Connection
3	Common Anode*	Common Cathode*	Common Anode*	Common Cathode*
4	Cathode C	Anode C	Cathode C	Anode C
5	Cathode D.P.	Anode D.P.	Cathode D.P.	Anode D.P.
6	Cathode B	Anode B	Cathode B	Anode B
7	Cathode A	Anode A	No Connection	No Connection
8	Common Anode*	Common Cathode*	Common Anode*	Common Cathode*
9	Cathode F	Anode F	Cathode H	Anode H
10	Cathode G	Anode G	Cathode G	Anode G

NOTES: 1. Pin 3 & 8 are internally connected.
2. Pin 5 & 6 are internally connected.

INTERNAL CIRCUIT DIAGRAM

A. LTS-546A

B. LTS-547A

C. LTS-548A

D. LTS-549A

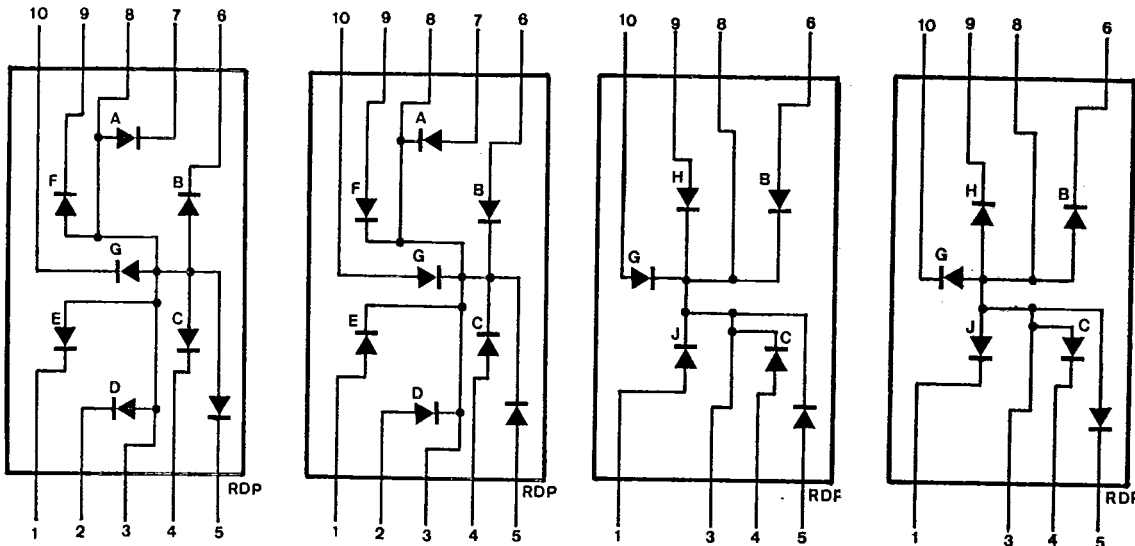

ABSOLUTE MAXIMUM RATINGS AT $T_A = 25^\circ\text{C}$

PARAMETER	RED	BRIGHT RED	GREEN	YELLOW	ORANGE	HI.-EFF. RED	UNIT
Power Dissipation Per Segment	55	40	75	60	75	75	mW
Peak Forward Current Per Segment (1/10 Duty Cycle, 0.1ms Pulse Width)	160	60	160	80	100	100	mA
Continuous Forward Current Per Segment	25	15	25	20	25	25	mA
Derating Linear From 25°C Per Segment	0.3	0.18	0.3	0.24	0.3	0.3	mA/ $^\circ\text{C}$
Reverse Voltage Per Segment	5	5	5	5	5	5	V
Operating Temperature Range	-25 $^\circ\text{C}$ to +85 $^\circ\text{C}$						
Storage Temperature Range	-25 $^\circ\text{C}$ to +85 $^\circ\text{C}$						
Solder Temperature 1/16 inch Below Seating Plane for 3 Seconds at 260 $^\circ\text{C}$							

**ELECTRICAL/OPTICAL CHARACTERISTICS AT $T_A = 25^\circ\text{C}$
LTS-540AR SERIES**

PARAMETER	SYMBOL	MIN.	TYP.	MAX.	UNIT	TEST CONDITION
Average Luminous Intensity	I_v	200	500		μcd	$I_F = 10\text{ mA}$
Peak Emission Wavelength	λ_p		655		nm	$I_F = 20\text{ mA}$
Spectral Line Half-Width	$\Delta\lambda$		24		nm	$I_F = 20\text{ mA}$
Forward Voltage, any Segment or D.P.	V_F		1.7	2.0	V	$I_F = 20\text{ mA}$
Reverse Current, any Segment or D.P.	I_R			100	μA	$V_R = 5\text{V}$
Luminous Intensity Matching Ratio	$I_v\text{-m}$			2:1		$I_F = 20\text{ mA}$

TYPICAL ELECTRICAL/OPTICAL CHARACTERISTIC CURVES

(25°C Ambient Temperature Unless Otherwise Noted)

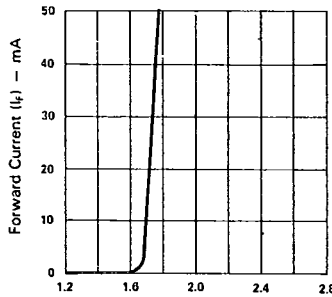

Fig. 1 FORWARD CURRENT Vs. FORWARD VOLTAGE.

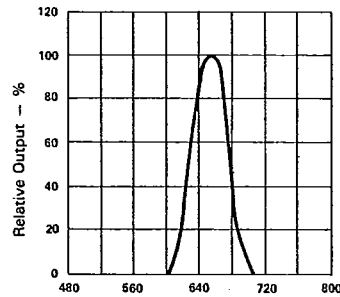

Fig. 2 SPECTRAL RESPONSE.

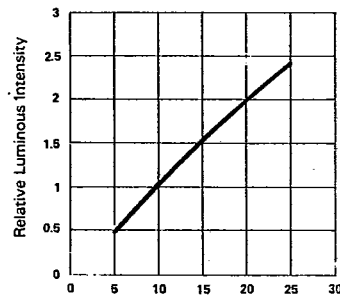

Fig. 3 RELATIVE LUMINOUS INTENSITY Vs. FORWARD CURRENT (PER SEGMENT).

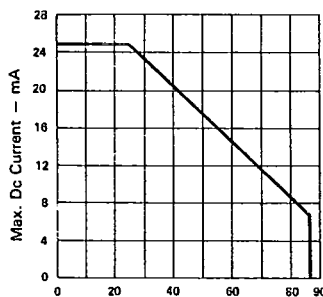

Fig. 4 MAX. ALLOWABLE DC CURRENT PER SEG. Vs AMBIENT TEMPERATURE.

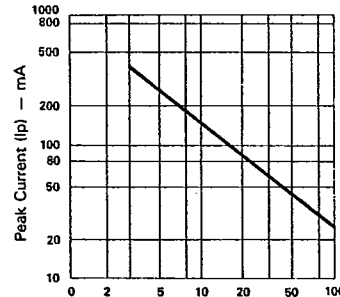

Fig. 5 MAX. PEAK CURRENT Vs. DUTY CYCLE.% (REFRESH RATE - F = 1 KHz)

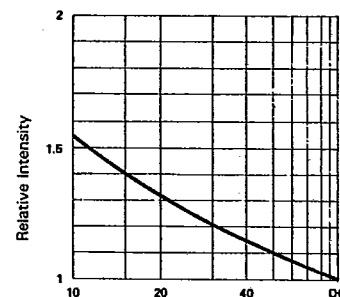

Fig. 6 LUMINOUS INTENSITY Vs. DUTY CYCLE% (AVERAGE $I_F = 10\text{mA}$ PER SEG.)

ELECTRICAL/OPTICAL CHARACTERISTICS AT $T_A = 25^\circ\text{C}$
LTS-540AP SERIES

PARAMETER	SYMBOL	MIN.	TYP.	MAX.	UNIT	TEST CONDITION
Average Luminous Intensity	I_V	300	750		μcd	$I_F = 10 \text{ mA}$
Peak Emission Wavelength	λ_P		697		nm	$I_F = 20 \text{ mA}$
Spectral Line Half-Width	$\Delta\lambda$		90		nm	$I_F = 20 \text{ mA}$
Forward Voltage, any Segment or D.P.	V_F		2.1	2.8	V	$I_F = 20 \text{ mA}$
Reverse Current, any Segment or D.P.	I_R			100	μA	$V_R = 5\text{V}$
Luminous Intensity Matching Ratio	$I_V\text{-m}$			2:1		$I_F = 20 \text{ mA}$



TYPICAL ELECTRICAL/OPTICAL CHARACTERISTIC CURVES

(25°C Ambient Temperature Unless Otherwise Noted)

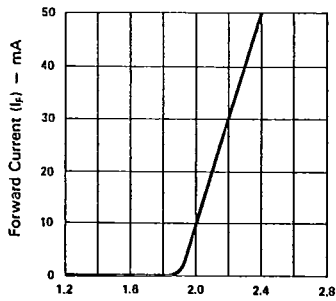

Forward Voltage (V_F) - Volts
 Fig. 1 FORWARD CURRENT vs. FORWARD VOLTAGE.

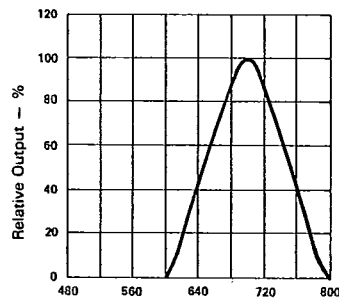

Wavelength (λ) - nm.
 Fig. 2 SPECTRAL RESPONSE.

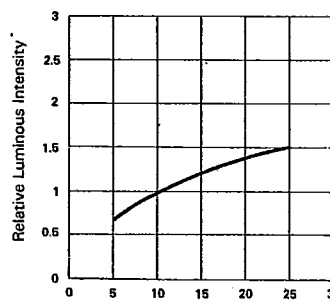

Forward Current (I_F) - mA
 Fig. 3 RELATIVE LUMINOUS INTENSITY vs. FORWARD CURRENT (PER SEGMENT).

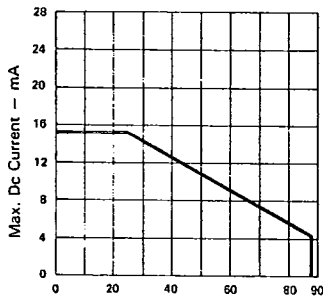

Ambient Temperature (T_A) - $^\circ\text{C}$
 Fig. 4 MAX. ALLOWABLE DC CURRENT PER SEG. vs AMBIENT TEMPERATURE.

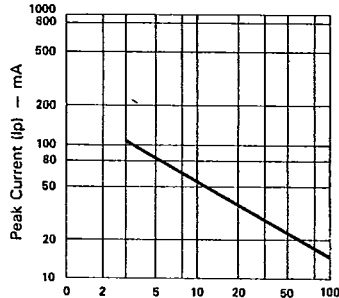

Duty Cycle %
 Fig. 5 MAX. PEAK CURRENT vs. DUTY CYCLE.% (REFRESH RATE - $F = 1 \text{ KHz}$)

ELECTRICAL/OPTICAL CHARACTERISTICS^{at} AT TA = 25°C
LTS-540AG SERIES

PARAMETER	SYMBOL	MIN.	TYP.	MAX.	UNIT	TEST CONDITION
Average Luminous Intensity	I_V	800	2000		μcd	$I_F = 10 \text{ mA}$
Peak Emission Wavelength	λ_p		565		nm	$I_F = 20 \text{ mA}$
Spectral Line Half-Width	$\Delta\lambda$		30		nm	$I_F = 20 \text{ mA}$
Forward Voltage, any Segment or D.P.	V_F		2.1	2.8	V	$I_F = 20 \text{ mA}$
Reverse Current, any Segment or D.P.	I_R			100	μA	$V_R = 5\text{V}$
Luminous Intensity Matching Ratio	$I_V\text{-m}$			2:1		$I_F = 20 \text{ mA}$

TYPICAL ELECTRICAL/OPTICAL CHARACTERISTIC CURVES

(25°C Ambient Temperature Unless Otherwise Noted)

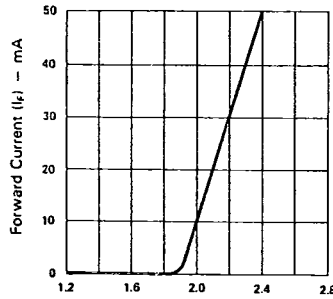

Fig. 1 FORWARD CURRENT Vs. FORWARD VOLTAGE.

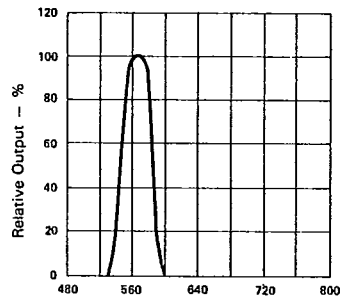

Fig. 2 SPECTRAL RESPONSE.

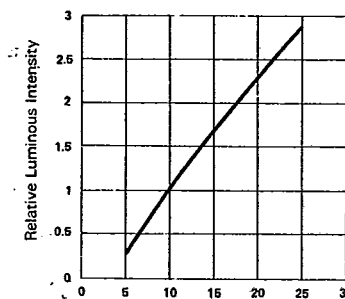

Fig. 3 RELATIVE LUMINOUS INTENSITY Vs. FORWARD CURRENT (PER SEGMENT).

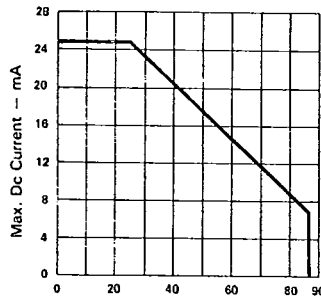

Fig. 4 MAX. ALLOWABLE DC CURRENT PER SEG. Vs AMBIENT TEMPERATURE.

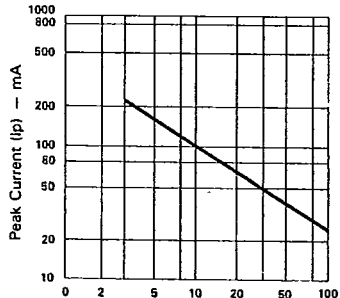

Fig. 5 MAX. PEAK CURRENT Vs. DUTY CYCLE.% (REFRESH RATE - F = 1 KHz)

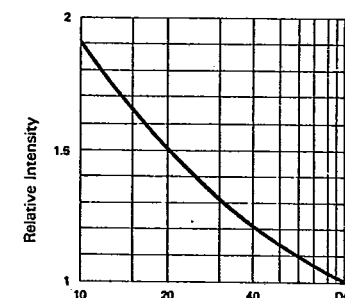

Fig. 6 LUMINOUS INTENSITY Vs. DUTY CYCLE.% (AVERAGE $I_F = 10\text{mA}$ PER SEG.)

ELECTRICAL/OPTICAL CHARACTERISTICS AT $T_A = 25^\circ\text{C}$
LTS-540AY SERIES

PARAMETER	SYMBOL	MIN.	TYP.	MAX.	UNIT	TEST CONDITION
Average Luminous Intensity	I_v	700	2000		μcd	$I_F = 10 \text{ mA}$
Peak Emission Wavelength	λ_p		585		nm	$I_F = 20 \text{ mA}$
Spectral Line Half-Width	$\Delta\lambda$		35		nm	$I_F = 20 \text{ mA}$
Forward Voltage, any Segment or D.P.	V_F		2.1	2.8	V	$I_F = 20 \text{ mA}$
Reverse Current, any Segment or D.P.	I_R			100	μA	$V_R = 5\text{V}$
Luminous Intensity Matching Ratio	$I_v\text{-m}$			2:1		$I_F = 20 \text{ mA}$

TYPICAL ELECTRICAL/OPTICAL CHARACTERISTIC CURVES

(25°C Ambient Temperature Unless Otherwise Noted)

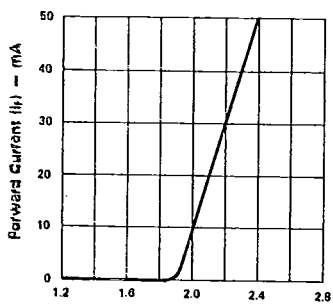

Fig. 1 FORWARD CURRENT Vs. FORWARD VOLTAGE.

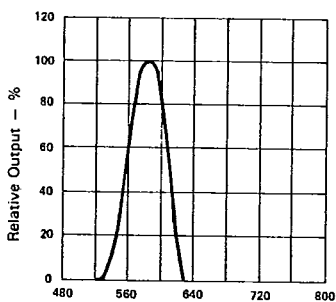

Fig. 2 SPECTRAL RESPONSE.

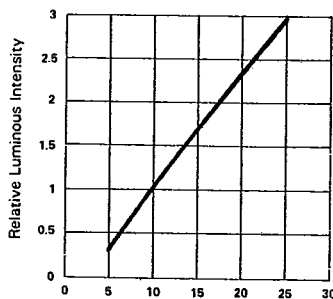

Fig. 3 RELATIVE LUMINOUS INTENSITY Vs. FORWARD CURRENT (PER SEGMENT).

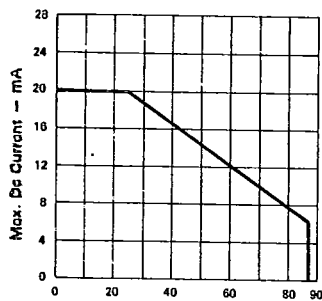

Fig. 4 MAX. ALLOWABLE DC CURRENT PER SEG. Vs AMBIENT TEMPERATURE.

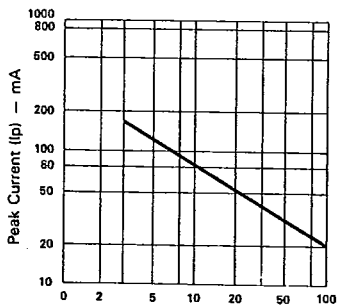

Fig. 5 MAX. PEAK CURRENT Vs. DUTY CYCLE.% (REFRESH RATE - $F = 1 \text{ KHz}$)

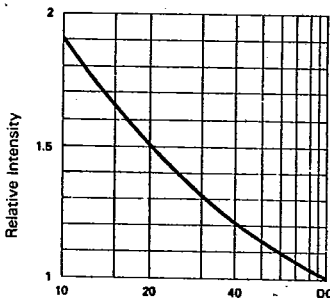
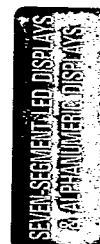

Fig. 6 LUMINOUS INTENSITY Vs. DUTY CYCLE% (AVERAGE $I_F = 10\text{mA}$ PER SEG.)



T-41-33

**ELECTRICAL/OPTICAL CHARACTERISTICS AT $T_A = 25^\circ\text{C}$
LTS-540AE SERIES**

PARAMETER	SYMBOL	MIN.	TYP.	MAX.	UNIT	TEST CONDITION
Average Luminous Intensity	I_v	800	2000		μcd	$I_F = 10\text{ mA}$
Peak Emission Wavelength	λ_p		630		nm	$I_F = 20\text{ mA}$
Spectral Line Half-Width	$\Delta\lambda$		40		nm	$I_F = 20\text{ mA}$
Forward Voltage, any Segment or D.P.	V_F		2.1	2.8	V	$I_F = 20\text{ mA}$
Reverse Current, any Segment or D.P.	I_R			100	μA	$V_R = 5\text{V}$
Luminous Intensity Matching Ratio	$I_v\text{-m}$			2:1		$I_F = 20\text{ mA}$

TYPICAL ELECTRICAL/OPTICAL CHARACTERISTIC CURVES
(25°C Ambient Temperature Unless Otherwise Noted)

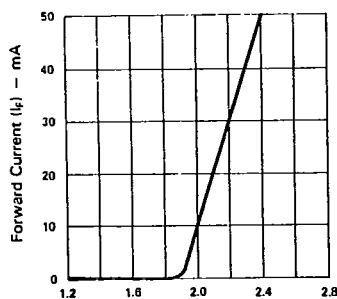

Fig. 1 FORWARD CURRENT Vs. FORWARD VOLTAGE.

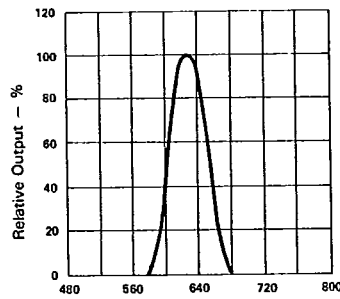

Fig. 2 SPECTRAL RESPONSE.

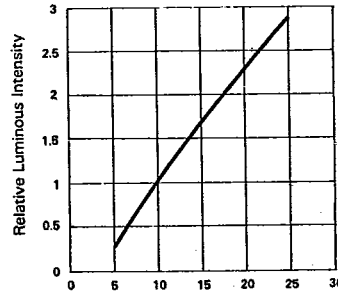

Fig. 3 RELATIVE LUMINOUS INTENSITY Vs. FORWARD CURRENT (PER SEGMENT).

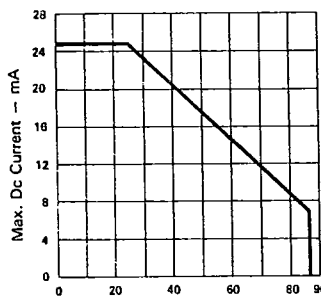

Fig. 4 MAX. ALLOWABLE DC CURRENT PER SEG. Vs AMBIENT TEMPERATURE.

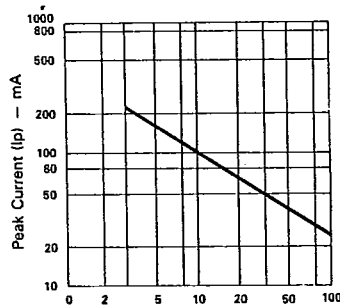

Fig. 5 MAX. PEAK CURRENT Vs. DUTY CYCLE.% (REFRESH RATE - F = 1 KHz)

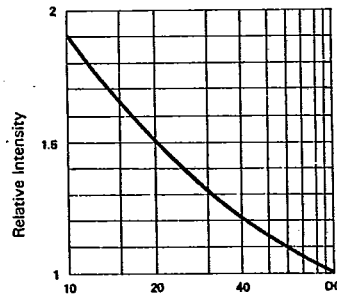

Fig. 6 LUMINOUS INTENSITY Vs. DUTY CYCLE% (AVERAGE $I_F = 10\text{mA}$ PER SEG.)

**ELECTRICAL/OPTICAL CHARACTERISTICS AT $T_A = 25^\circ\text{C}$
LTS-540AHR SERIES**

PARAMETER	SYMBOL	MIN.	TYP.	MAX.	UNIT	TEST CONDITION
Average Luminous Intensity	I_V	900	2000		μcd	$I_F = 10\text{ mA}$
Peak Emission Wavelength	λ_p		635		nm	$I_F = 20\text{ mA}$
Spectral Line Half-Width	$\Delta\lambda$		40		nm	$I_F = 20\text{ mA}$
Forward Voltage, any Segment or D.P.	V_F		2.1	2.8	V	$I_F = 20\text{ mA}$
Reverse Current, any Segment or D.P.	I_R			100	μA	$V_R = 5\text{V}$
Luminous Intensity Matching Ratio	$I_V\text{-m}$			2:1		$I_F = 20\text{ mA}$

TYPICAL ELECTRICAL/OPTICAL CHARACTERISTIC CURVES

(25°C Ambient Temperature Unless Otherwise Noted)

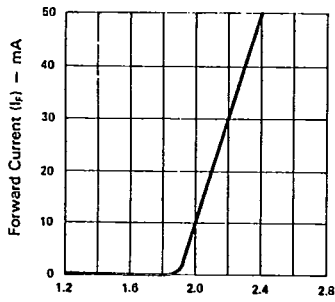

Forward Voltage (V_F) - Volts
Fig. 1 FORWARD CURRENT Vs. FORWARD VOLTAGE.

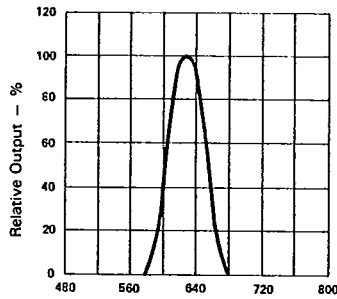

Wavelength (λ) - nm.
Fig. 2 SPECTRAL RESPONSE.

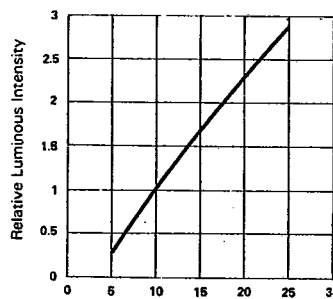

Forward Current (I_F) - mA
Fig. 3 RELATIVE LUMINOUS INTENSITY Vs. FORWARD CURRENT (PER SEGMENT).

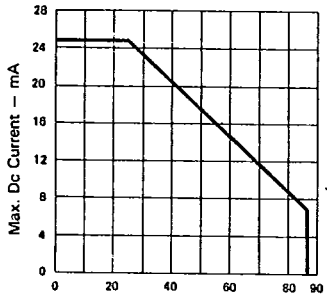

Ambient Temperature (T_A) - $^\circ\text{C}$
Fig. 4 MAX. ALLOWABLE DC CURRENT PER SEG. Vs AMBIENT TEMPERATURE.

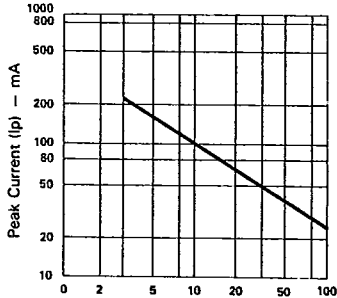

Duty Cycle %
Fig. 5 MAX. PEAK CURRENT Vs. DUTY CYCLE.% (REFRESH RATE - $F = 1\text{ KHz}$)

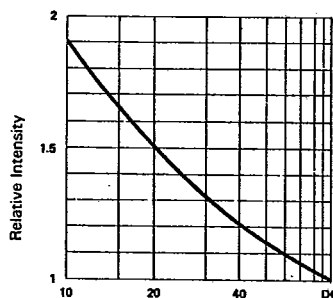

Duty Cycle %
Fig. 6 LUMINOUS INTENSITY Vs. DUTY CYCLE% (AVERAGE $I_F = 10\text{mA}$ PER SEG.)



PACKAGING

T-90-20

Reel Packaging (Axial Lead Units)

DEVICE TYPE	COMPONENT SPACE (MM) "A"	TAPE SPACE (MM) "B"	REEL DIA (MM) "D"	QUANTITY (EA)		CARTON	
				REEL	CARTON	SIZE (MM)	WEIGHT (KG)
DO-41 DO-41L	5±0.5	52.4±1.5	326~336	5000	20K	355 x 355 x 355	10.5
DO-201AD	10±0.5	52.4±1.5	326~336	1200	4.8K	355 x 355 x 355	9.0
P6(Aleg)	10±0.5	52.4±1.5	326~336	700	2.8K	355 x 355 x 355	8.8

The C dimension of Fig. 3 is between 3.17m.m. and 635mm greater than the length of the component involved.

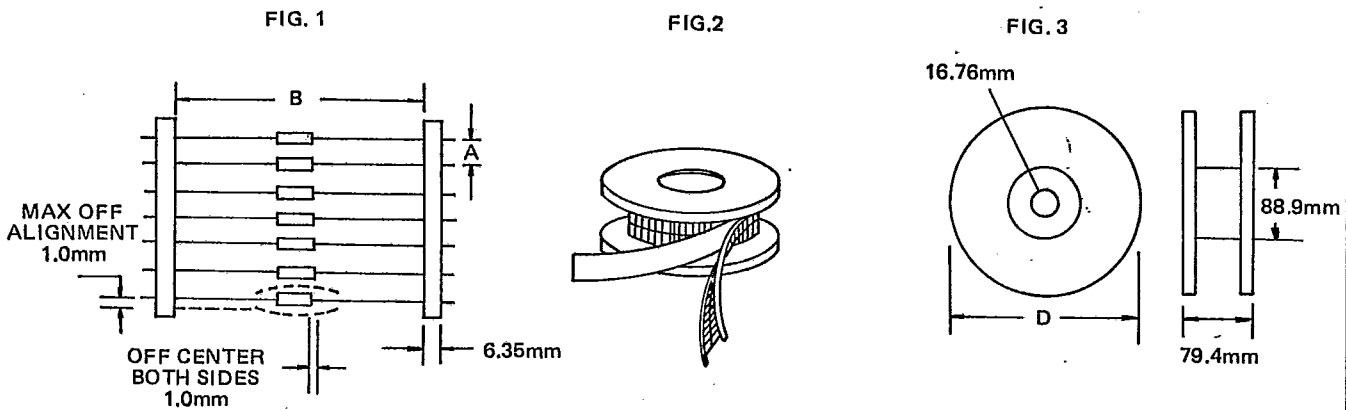

Bulk Packaging (Axial Lead Devices and Bridge Rectifiers)

DEVICE TYPE	PACKAGING SIZE (MM)		QUANTITY (EA)		APPROX GROSS WEIGHT (KG)	
	BOX	CARTON	BOX	CARTON	BOX	CARTON
DO-41 DO-41L	196 x 84 x 20	450 x 210 x 250	1000	50K	0.38	20
DO-201AD	305 x 93 x 59	355 x 355 x 355	1000	20K	1.35	28
P6(Aleg)	305 x 93 x 59	355 x 355 x 355	500	10K	1.2	24.5
PBM	357 x 125 x 60	530 x 360 x 340	1000	20K	1.5	32.3
PBDF	495 x 155 x 145	500 x 325 x 305	5000	20K	5.1	21.5
PBP	357 x 125 x 60	530 x 360 x 340	500	10K	1.5	31.5
PBL	375 x 220 x 155	470 x 385 x 455	1000	5K	5.7	30.5
PBPC-6	357 x 125 x 60	560 x 360 x 340	250	5K	1.1	22
PBPC-8	357 x 125 x 60	560 x 360 x 340	250	5K	1.7	35
KBPC	375 x 220 x 365	470 x 390 x 385	500	1K	15.1	31.5
KBPC-W	375 x 220 x 365	470 x 390 x 385	500	1K	14.5	30.0

AMMO BOX PACKAGING

BOX SIZE

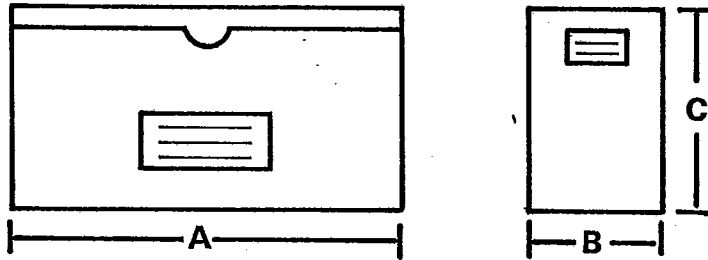

Unit:m. m.

Packaging	Products Outline	Dimension *A*	Dimension *B*	Dimension *C*	Q'ty per BOX
26MM Horizontal Ammo Pack	DO-41 DO-41L(0.6mm Lead)	255	50	95	3K
					3K
52MM Horizontal Ammo Pack	DO-41and DO-41L DO 201AD	250	75	92	3K
					0.8K

CARTON SIZE

Unit:m. m.

Packaging	Products Outline	length	Width	High	Q'ty Per Carton
26MM Horizontal Ammo Pack	DO-41 DO-41L(0.6mm Lead)	330	310	268	42K
					48K
52MM Horizontal Ammo Pack	DO-41and DO-41L DO 201AD	355	355	340	12K

PREFORMED LEAD DRAWING

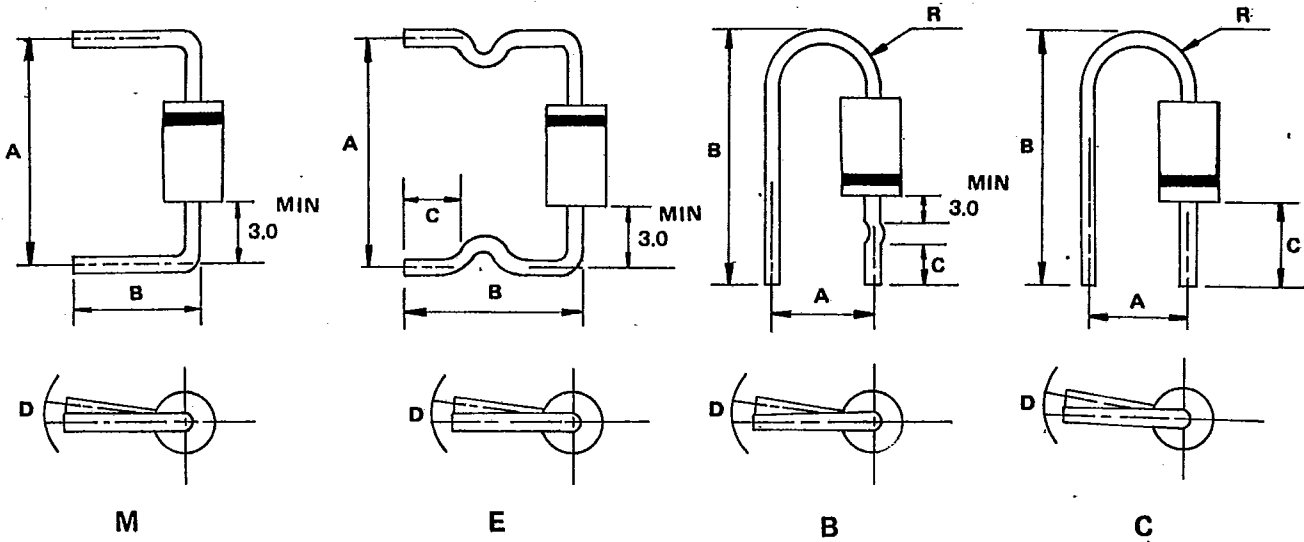

Case type	Preformed type	A (mm)		B (mm)		C (mm)		D (mm)		R (mm)	
		range	tolerance	range	tolerance	range	tolerance	range	tolerance	range	tolerance
D041	M	9.0-20.0	1.0	8.0-22.0	±0.5	-	-	1.5	max	-	-
	E	11.0-20.0	±1.0	11.0-16.0	±1.0	4.0-5.0	±0.5	1.5	max	-	-
	B	7.5	±0.5	19.0-22.0	±0.5	7.5	±0.5	1.5	max	2.5-4.0	Typ
	C	4.5	±0.8	18.0-19.0	±0.5	9.0	±0.5	1.5	max	2.5-4.0	Typ
D0201AD	M	15.0-20.0	±1.0	8.0-22.0	±1.0	-	-	2.0	max	-	-
	E	15.0-20.0	±1.0	10.0-22.0	±1.0	3.0-15.0	±0.5	2.0	max	-	-
P6(Aleg)	M	15.0-20.0	±1.0	8.0-22.0	±1.0	-	-	2.0	max	-	-